

Regulierventil /Schrägsitzventil Typ RVX-F

DN15 - DN80

Technische Daten

Technik:	2/2 Wege-Schrägsitzventil mit Regelfunktion
Betätigung:	Handrad
Betriebsdruck:	Max. 16 bar
Anschluss:	Flansche PN10/16
Medium:	Neutrale, saubere, flüssige
Mediumstemp.:	-10°C / +80°C

Abmessungen (mm)

Art.-No.	DN	L	H	D	LK	n	d
09 RVX 015	15	130	133	95	65	4	14
09 RVX 020	20	150	148	105	75	4	14
09 RVX 025	25	160	153	115	85	4	14
09 RVX 032	32	180	175	140	100	4	18
09 RVX 040	40	200	185	150	110	4	18
09 RVX 050	50	230	198	165	125	4	18
09 RVX 065	65	290	198	185	145	4	18
09 RVX 080	80	310	205	200	160	8	18

Werkstoffe

Gehäuse:	Edelstahl 1.4408
Schliesskörper:	Edelstahl 1.4404
Flansche:	Edelstahl 1.4571
Sitzdichtung:	PTFE
Spindeldichtung:	PTFE
Handrad:	Kunststoff

Durchflusswerte m3/h

Siehe Seite 2 | 2

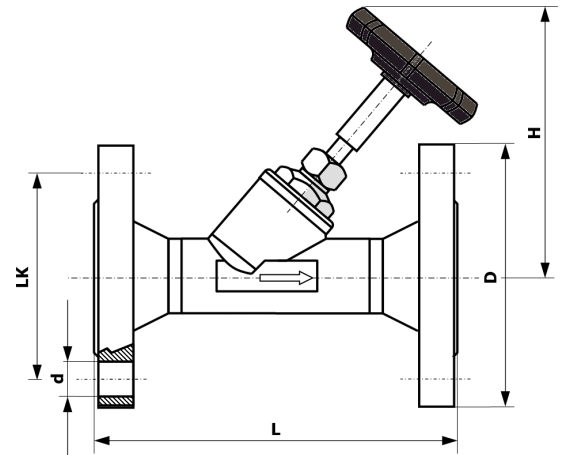

Durchflusswerte m³/h

½", DN15 - Kv-Wert / Kv-value: 3,6m³/h

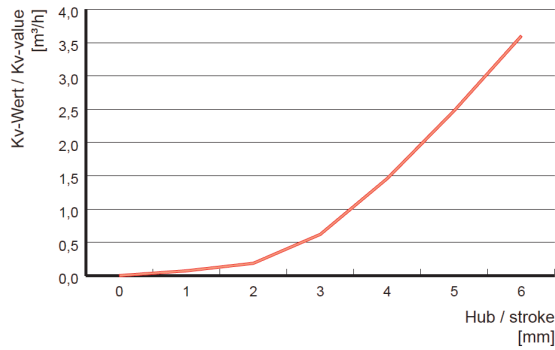

¾", DN20 - Kv-Wert / Kv-value: 7,5m³/h

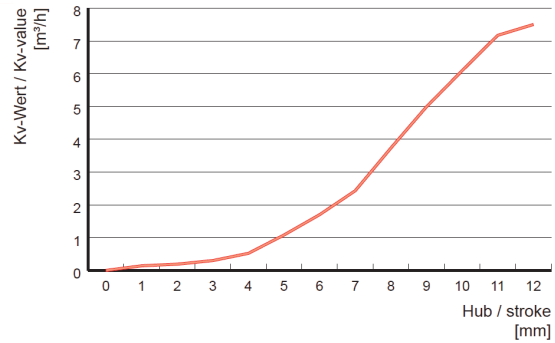

1", DN25 - Kv-Wert / Kv-value: 12,0m³/h

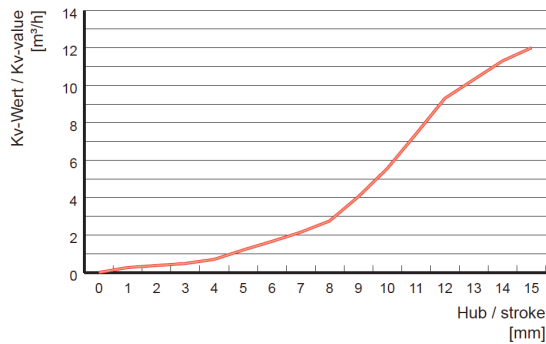

1¼", DN32 - Kv-Wert / Kv-value: 18,0m³/h

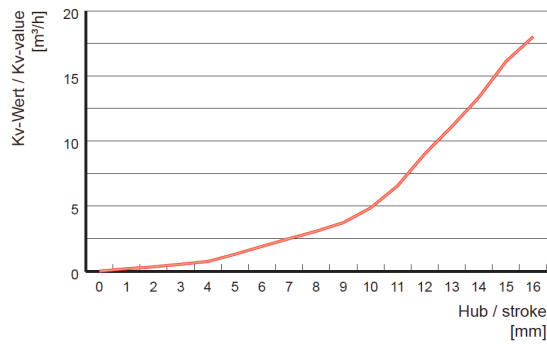

1½", DN40 - Kv-Wert / Kv-value: 27,0m³/h

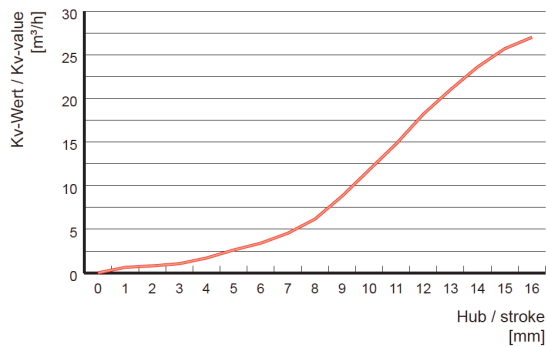

2", DN50 - Kv-Wert / Kv-value: 42,0m³/h

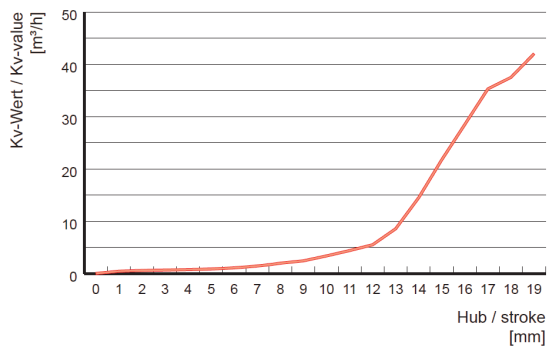

G2½", DN65 - Kv-Wert / Kv-value: 65,0m³/h

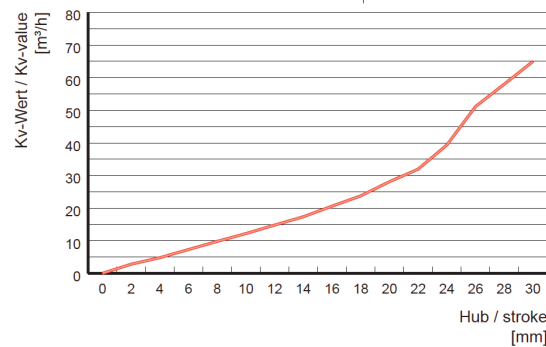

G3", DN80 - Kv-Wert / Kv-value: 100m³/h

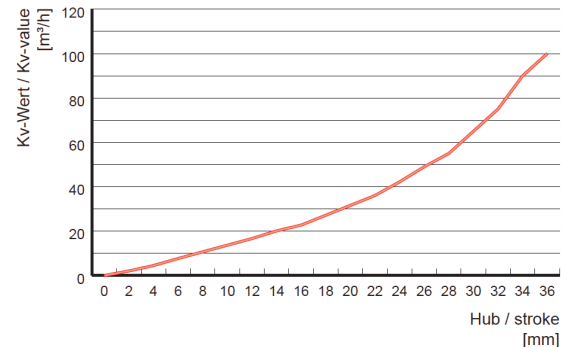

Kv Wert mit Regelkegel, Ventil vollständig geöffnet, angegeben in m³/h bei Δp = 1 bar